

SOLUTION

LASER CUTTING



Quattro



USER FRIENDLY, COMPACT LASER CUTTING MACHINE

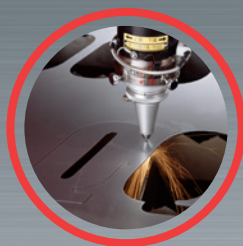

AMADA

Quattro

USER FRIENDLY, COMPACT LASER CUTTING MACHINE

POWERFUL COMPACT MACHINE FOR CUTTING SMALL, MEDIUM OR EVEN HEAVY GAUGE PARTS

The Quattro is one of the most flexible, cost efficient, space saving and easy to use lasers anywhere. Its ease of use coupled with low operating costs offer excellent price / performance ratio.

Many manufacturers have a large variety of parts, but only produce quantities of one or two pieces. The Quattro is ideal for such small volumes whether they are actual production parts or just R&D parts. Utilizing scrap and trimmings to produce small parts is easy to do on the Quattro.



Photograph includes optional equipment

TYPICAL PROCESSING SAMPLES

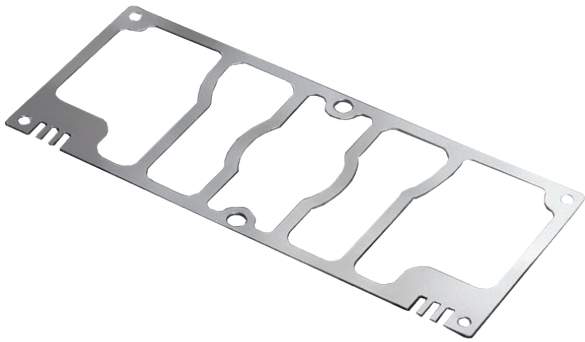

Material: Stainless steel 0.1 mm



Material: Zinc coated mild steel 1.0 mm



Material: SPHC 6.0 mm

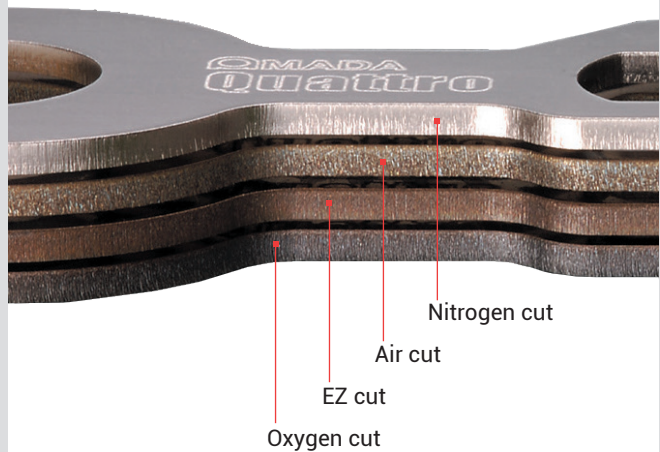

Quattro

SMALLEST FOOTPRINT IN ITS CLASS

COMPACT & ACCESSIBLE



With only 6.4 m² needed to install the machine, the Quattro is the smallest AMADA laser machine. The oscillator, power supply and NC unit are combined into one compact system. The 3 fully enclosed sides ensure compliance with safety standards without hindering ease of use due to the large opening doors at the front and 2 drop down doors on the right and rear sides.



The flying optic design allows for material to be processed in a very small space by moving only the cutting head.

EASY OPERATION

PRATICAL SOLUTIONS

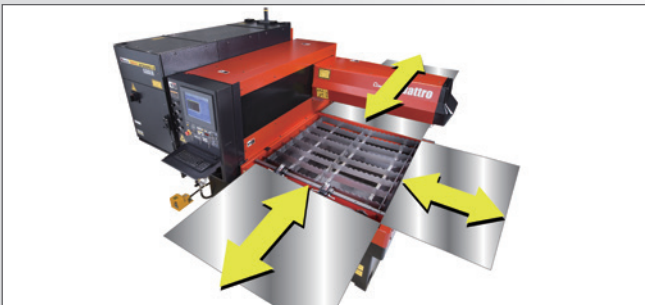

The three accessible sides of the Quattro ease loading and unloading. Worksheets larger than the processing range can be processed using manual repositioning.



The touch screen AMNC control offers easy operation and has many features. It can store 10 sets of cutting conditions for up to 999 different materials. It improves productivity and minimizes mistakes.

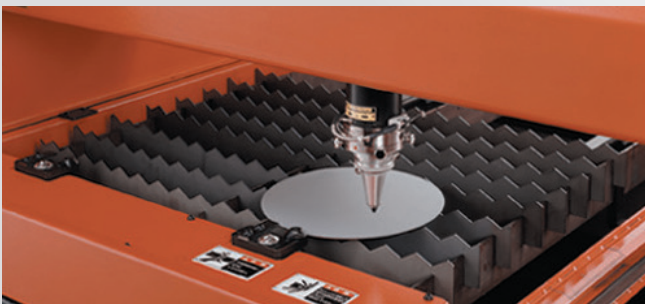

The flying optics and skid table design reduce the need for securing the material with clamps, ideal for processing parts utilizing fixtures or to cut irregular scrap or trimmings.

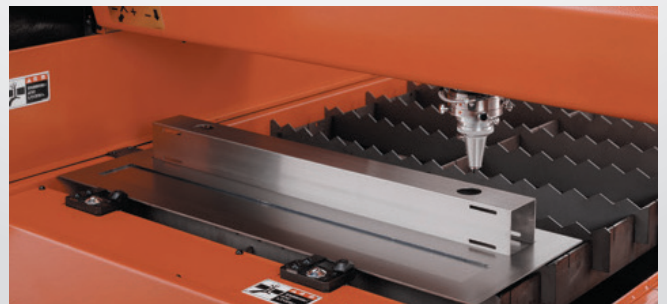

PROCESS RELIABILITY

ACCURATE & ROBUST



The distance between the nozzle and the material is automatically detected by a sensor and held constant. This results in high accuracy processing with high speeds and stability.

The Quattro utilizes the laser beam as its only tool. Programming of complex shapes is simple to do: the laser simply follows the outline of the part. The oscillator generates a beam shape with minimal fluctuation, resulting in improved cutting quality.

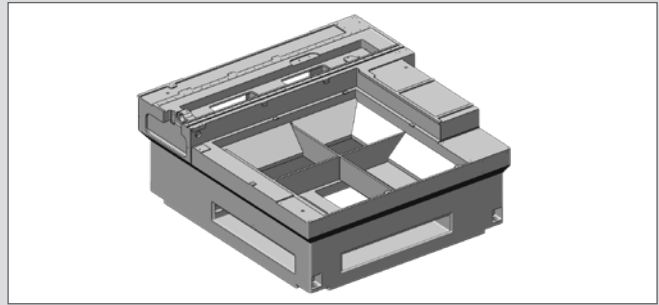

Reliability and accuracy are guaranteed on the Quattro due to the use of a high quality cast frame. This reduces unwanted vibrations and keeps high rigidity of the entire structure, ensuring ultimate process reliability and machine longevity.

COST EFFECTIVE

ECONOMICAL & RESOURCE SAVING

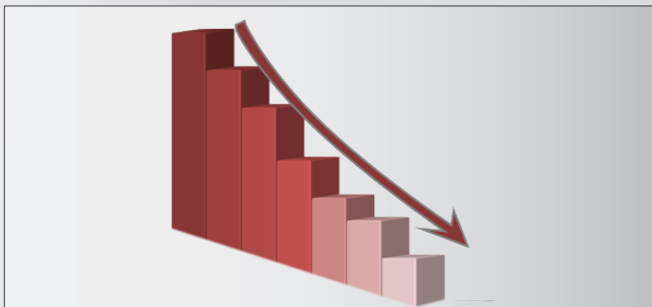

By including only the necessary laser features on the Quattro, initial cost, operating cost and maintenance on this simple design is greatly reduced. Ease of use associated with low operating costs provide excellent price/performance ratio.

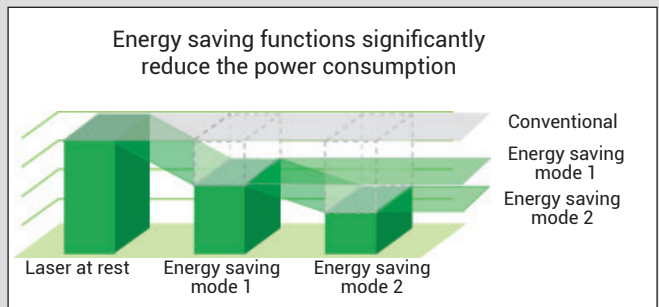

A high performance fast axial flow oscillator is utilised on the machine which includes 2 power saving modes. Depending on the machine status, the power saving features control the oscillator and chiller automatically to reduce the electrical consumption and, therefore, overall running costs.

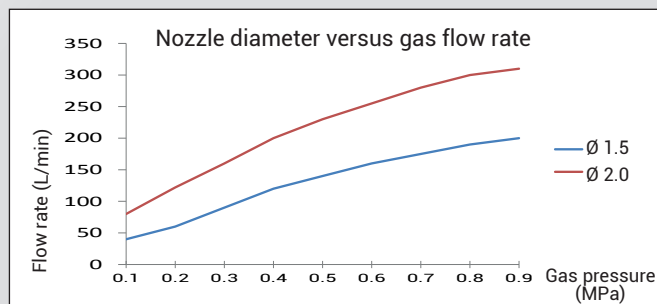

A 1.5mm nozzle can be used on the Quattro reducing the flow rate of the assist gas. This translates into a sizable reduction in the assist gas cost.

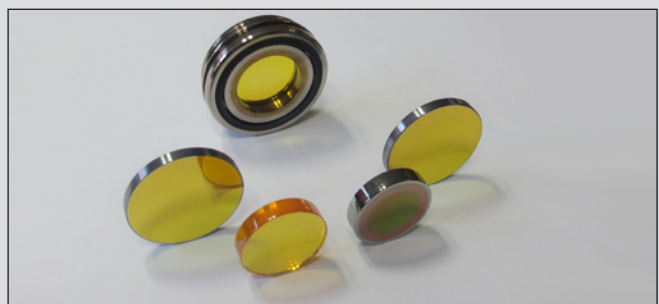

Comprehensive measures have been implemented to extend the service life of the cutting lens and the mirrors in the system.

FUNCTIONS AND OPTIONAL EQUIPMENT

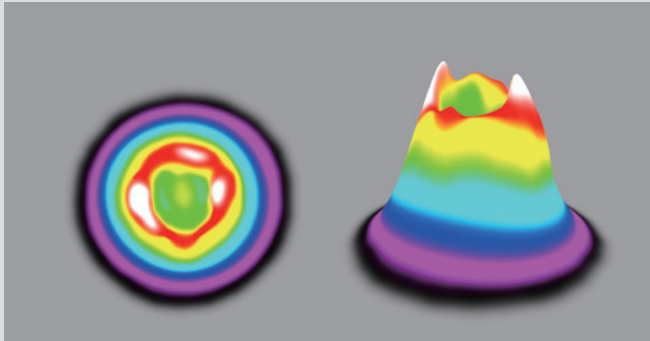

High Quality Beam

The latest generation laser oscillator has the optimum beam characteristics to ensure high quality edge surfaces.

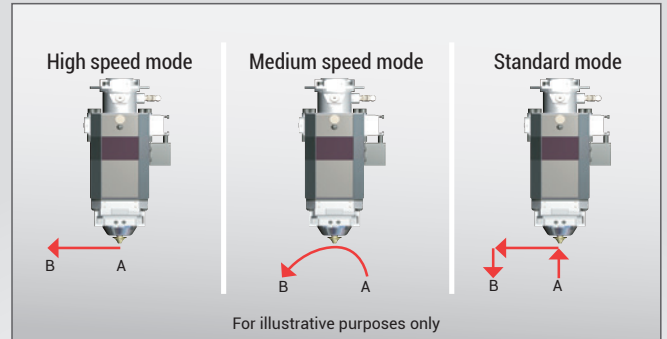

One-touch change of laser head operating mode

The AMNC-F control panel allows three operating modes to be selected for the laser head, depending on specific cutting operations to be performed. The operation of the laser head can be changed by one touch on the screen.

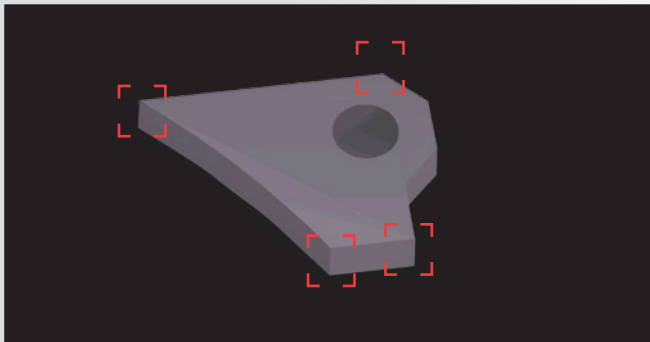

Automatic variable corner data

The AMNC-F control panel has the ability to automatically vary the cutting data depending on the angle of each corner of the part. This provides high-grade regardless of component geometry.

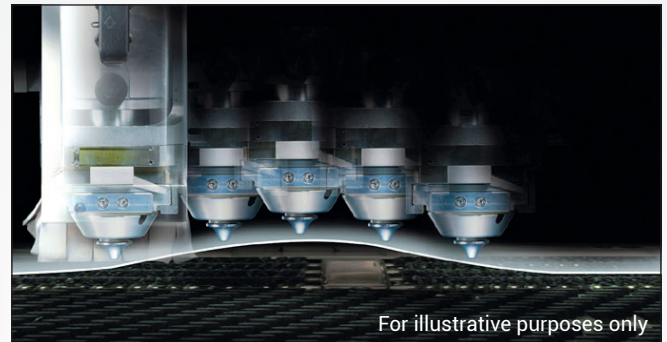

Automatic HS Capacitance Head

In order to ensure reliable processing, the Quattro is equipped with AMADA's automatic HS capacitance sensing head. This smoothly and quickly follows the sheet profile to maintain a consistent cut even when the sheet is not 100% flat.



Cutting Lens assembly

Standard 5" lens assembly for all materials and thicknesses.

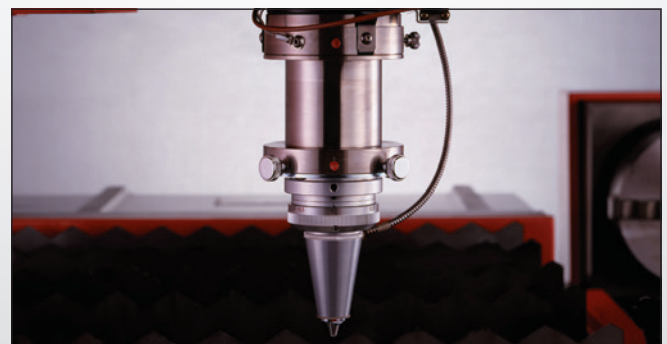

Non contact sensor for 7.5" focusing lens

Effective when cutting heavier gauge material, with dedicated sensor head.



Electronic Hand Wheel

The standard electronic hand wheel device allows quick, easy, incremental manual positioning of the laser cutting head. All axes of the machine can be positioned with an accuracy of 0.001mm if required.

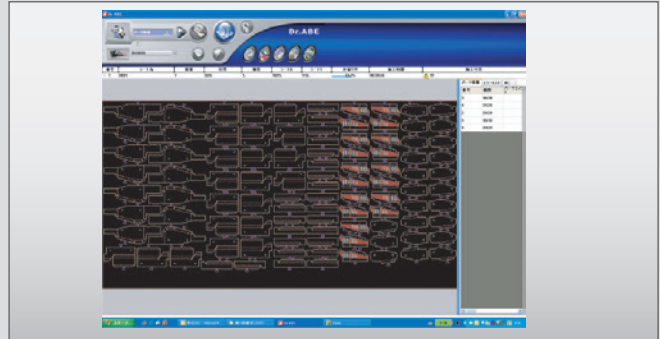

CAD/CAM

This fully automatic CAM system nests all the user defined parts and quantities, applies punch tooling/laser profiles, defines the processing sequence and generates the NC program. Increase productivity for your punch, laser or combination machines.

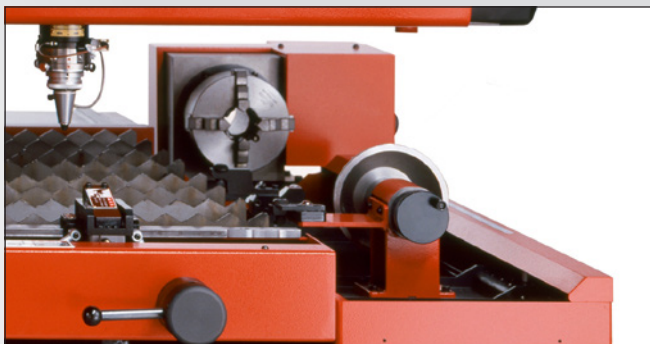

Pipe indexing model

Easy to use pipe indexing unit makes it simple to cut both pipe and sheets.



THE SHEET METAL DIGITAL FACTORY

AMADA proposes digital manufacturing using VPSS (Virtual Prototype Simulation System).

All data is created in the office and utilised in the workshop via a network.

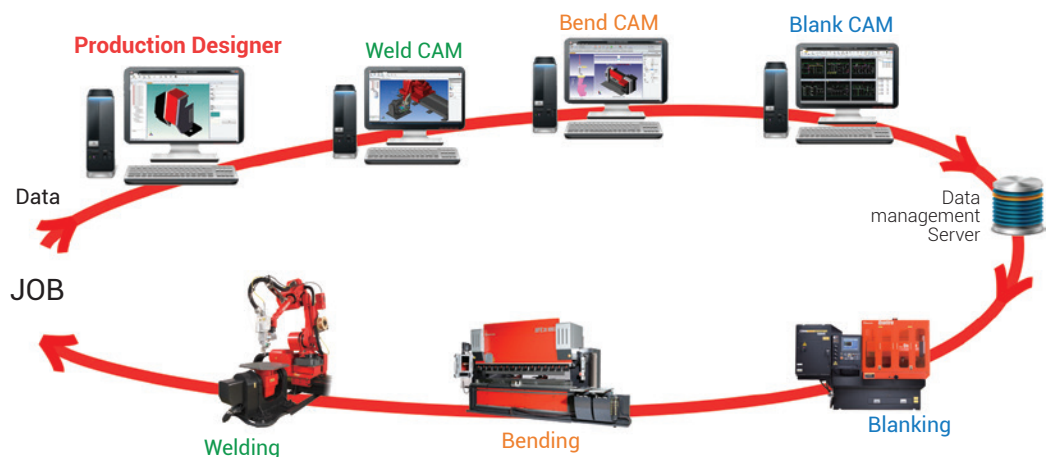

Unit : mm

DIMENSIONS

Quattro 1 kW

(L) 2900 x (W) 2450 x (H) 2160

Quattro 2 kW

(L) 2950 x (W) 2450 x (H) 2160

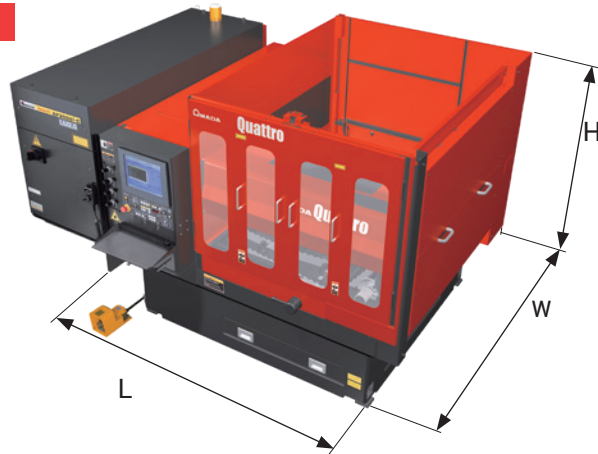

MACHINE SPECIFICATIONS

Quattro			
Numerical control			AMNC-F
Controlled axis			X, Y (two axes controlled simultaneously) + Z
Axis travel distance	X x Y x Z	mm	1260 x 1260 x 100
Maximum processing dimensions	X x Y x Z	mm	1250 x 1250 x 100
Maximum simultaneous feed rate	X/Y	m/min	42
Repeatable positioning accuracy		mm	±0.01
Maximum material mass	AF 1000i-C	kg	80
	AF 2000i-C LU2.5	kg	160
Processing surface height		mm	855
Mass of machine (Main unit only)	AF 1000i-C	kg	3750
	AF 2000i-C LU2.5	kg	4150

OSCILLATOR SPECIFICATIONS

			AF 1000i-C	AF 2000i-C LU2.5
Beam generation			High-frequency discharge excited, high speed axial-flow type	
Maximum power		W	1000	2500
Wavelength		µm	10.6	
Maximum processing thickness	Mild steel	mm	6	12
	Stainless steel		2	5
	Aluminium		1	4

Specifications, appearance, and equipment are subject to change without notice by reason of improvement.

 For your safe use
Be sure to read the user manual carefully before use.
When using this product, appropriate personal protection equipment must be used.

 Laser class 1 when operated in accordance with CE Regulations

Hazard prevention measures are removed in the photos used in this catalogue.

AMADA UK LTD.

Spennells Valley Road,
Kidderminster,
Worcestershire DY10 1XS
United Kingdom
Tel: +44 (0)1562 749500
Fax: +44 (0)1562 749510
www.amada.co.uk

AMADA SA

Paris Nord II
96, avenue de la Pyramide
93290 Tremblay en France
France
Tél : +33 (0)149903000
Fax : +33 (0)149903199
www.amada.fr

AMADA GmbH

AMADA Allee 1
42781 Haan
Germany
Tel: +49 (0)2104 2126-0
Fax: +49 (0)2104 2126-999
www.amada.de

AMADA ITALIA S.r.l.

Via AMADA I., 1/3
29010 Pontenure (PC)
Italia
Tel: +39 (0)523-872111
Fax: +39 (0)523-872101
www.amada.it

